

Our solutions for Electronics

We develop, design and create
the best solution for you.

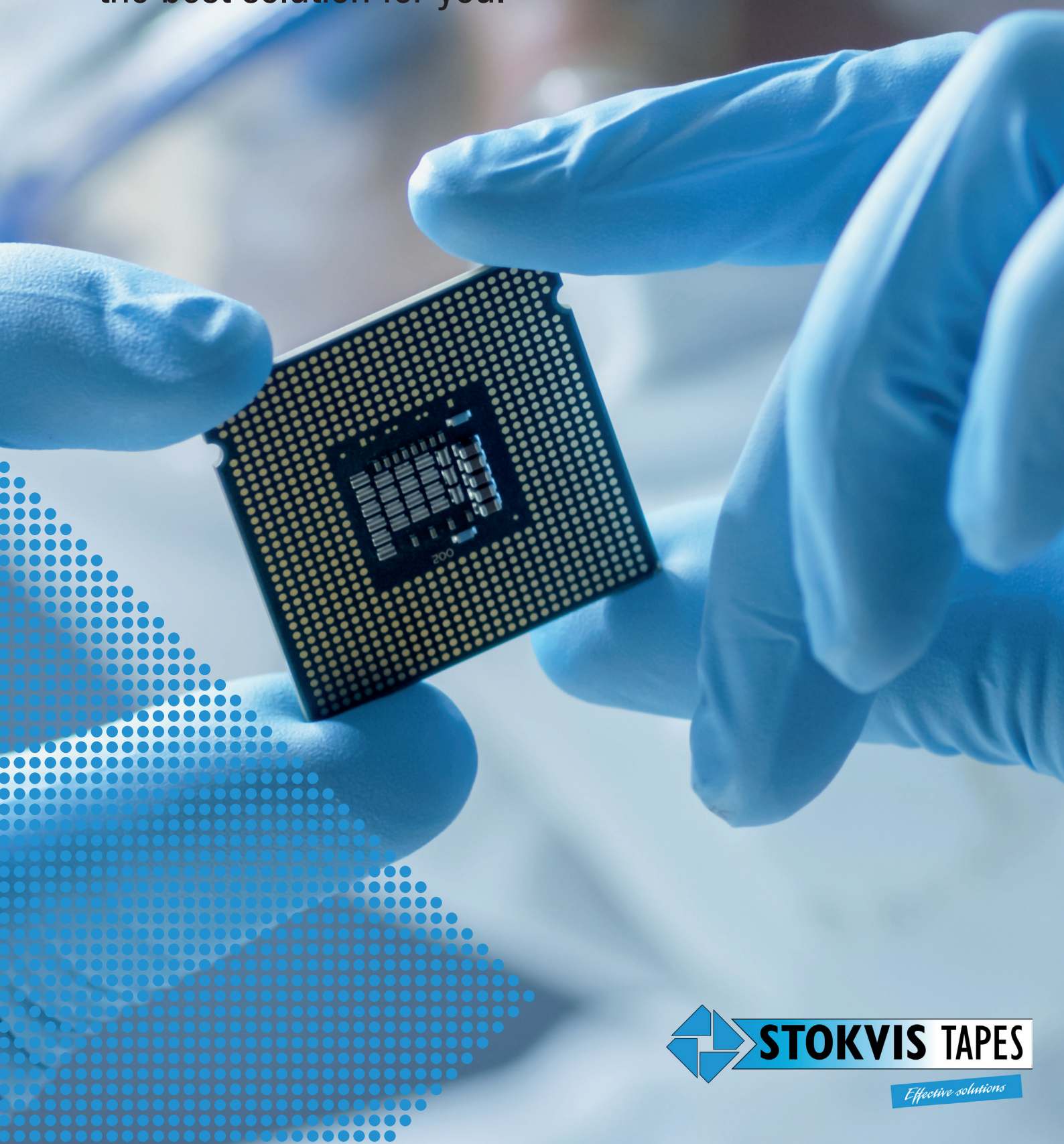

Effective solutions

ABOUT STOKVIS TAPES

From the concept phase through to material selection, design, production, packaging and delivery: With our process development expertise, we support our customers in developing innovative and unique products.

We help our customers to enhance the product development, shorten the development time and prepare the parts for the most efficient mass production.

Stokvis Tapes is dedicated to supply only high quality products that match customers specifications and tolerances with a level of service that meets their most demanding requirements. Our processes are continuously monitored by external certifications and customer audits to ensure that they fulfil application requirements and specification. In addition, we continuously develop ourselves and our product solutions.

A unique service that distinguishes Stokvis Tapes from its competition is the provision of independent, fast, high quality and accurate testing of adhesive tape properties and characteristics to determine how they will perform in relation to customers own materials. Our customers satisfaction is our top priority.

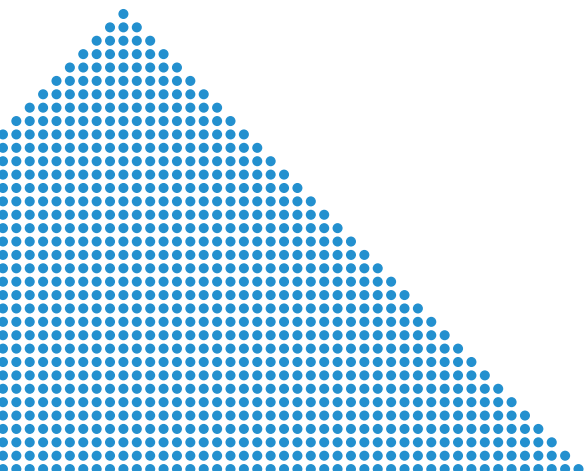

THERMAL MANAGEMENT

Stokvis provides a wide range of solutions within thermal management. Stokvis' thermal management solutions are separated into two areas:

1. Thermal interface materials (TIM)
2. Heat spreader solutions

Thermal Interface Materials (TIM)

Within the thermal interface material portfolio, Stokvis offers our Stoktherm product series with either acrylic or silicone based material. The Stoktherm product range supports a wide range of thermal conductivity (1-25W/mk), with excellent electrical insulation properties and a wide range of material hardness down to shore 00-05 at V-0 flammability rating.

Heat spreader solutions

Within the thermal heat spreader material portfolio, Stokvis offers different solutions, for example, graphite, copper and aluminium. For graphite materials, the heat conductivity in X & Y directions can be increased up to 1500W/mk. Stokvis' experience in part design and testing allows unique part designs tailored for each application.

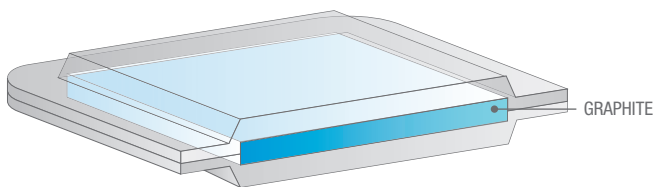

Envelop design die cut part with sealed edges

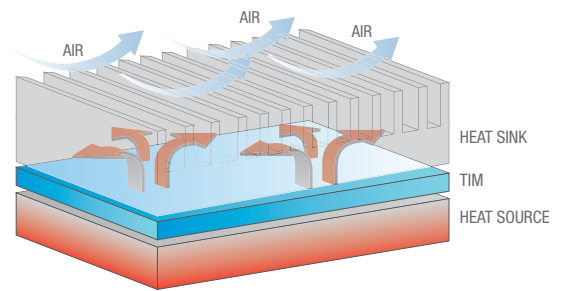

Correctly selected Thermal Interface Material (TIM) secures the good connection and stable heatflow between heat source and heat sink.

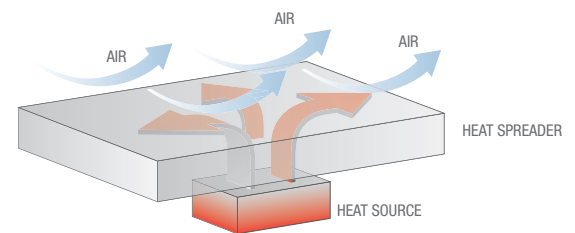

High function heat spreader

- a) Removes the heat quickly from the hot spot
- b) Cools down the heat source temperature



Tailored thermal conductivity



Tailored thickness and softness



Best in class electrical properties



Flame retardant

THERMAL MANAGEMENT | PRODUCT OVERVIEW

TIM MATERIALS

	SP(X) RANGE (silicone based)	TP RANGE (acrylic based)	TC RANGE (acrylic based)
Main application	thermal management & electric isolation	thermal management & electric isolation	thermal management & electric isolation
Material	thermal conductive silicone (fiber glass carrier can be added)	thermal conductive acrylic	thermal conductive acrylic with adhesive
Thickness range (mm)	0,5-6	0,2-2	0,2
Thermal conductivity range (W/mk)	1-25	1-3	0,90
Hardness (shore 00)	5-100	N/A	N/A
Temperature range starting from (°C)	-50 to +200	-40 to +120	-40 to +120
Breakdown voltage (kV/mm)	≤ 5	≤ 4	≤ 10
Flammability	V-0	V-0	VTM-0

HEAT SPREADER MATERIALS

	GRAPHITE	COPPER	ALUMINIUM
Main application	heat spreader	thermal management / grounding / shielding	thermal management / shielding
Thickness range (microns)	25	12, 25, 50 and 100	12, 25, 50 and 100
Thermal conductivity X&Y directions (W/mk)	1500	370	270
Thermal conductivity through the material (W/mk)	25	370	270
Temperature range starting from (°C)	-40 to +85	-40 to +85	-40 to +85
Adhesive	one or two sides	one or two sides	one or two sides

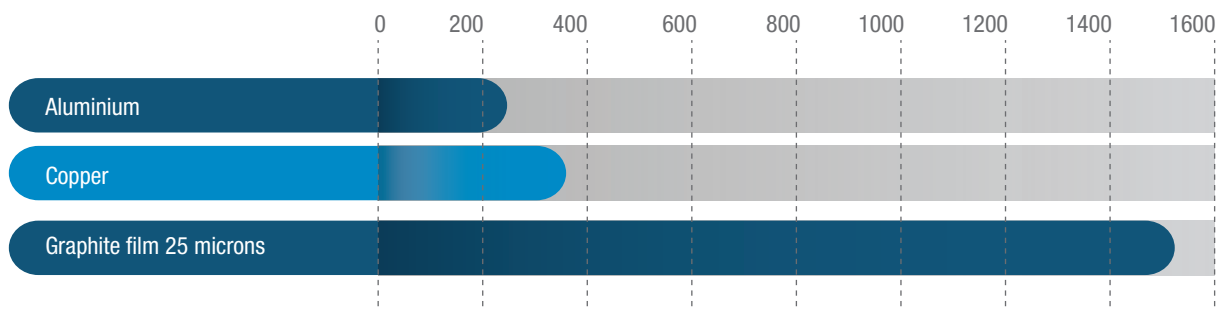

Material thermal conductivity (W/mk)

ELECTRICAL SHIELDING & GROUNDING APPLICATIONS

Stokvis' electrical grounding offerings include multiple electrically conductive solutions, from conductive tapes to the grounding/electrically conductive foams.

Our standard conductive tape solutions are copper carrier based, however, the carrier material can be changed to aluminium or conductive fibre based on special requirements. Conductive adhesive layers can be added on one or both sides of the carrier material, depending on the functional needs.

Stokvis' electrically conductive foam (DLZ-range) is based on foam with nickel-copper fibres. The foam has a high compression rate and low resistance level.

Stokvis' conductive foams are also available with a wraparound design, where the conductive material is wrapped around the foam to secure low resistance and low compression force with a stable compression set.

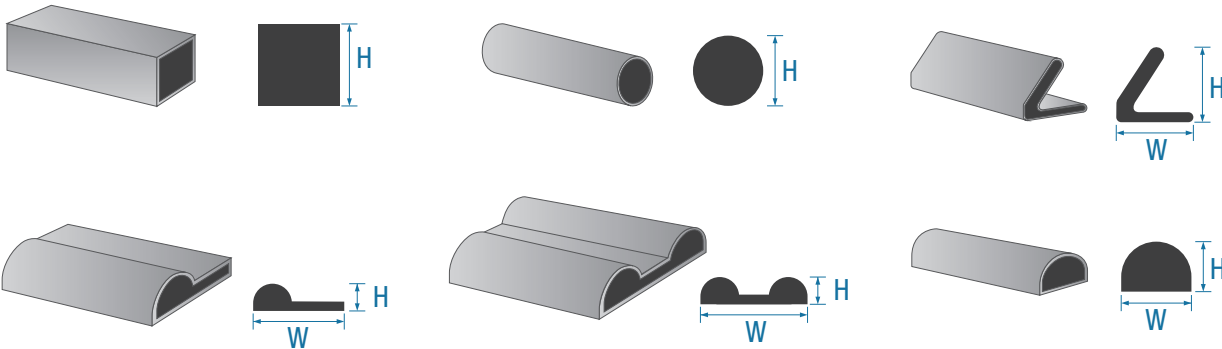

Choose your shape, choose your size, choose your density.



Electro Static Discharge



Grounding



Shielding

ELECTRICAL CONDUCTIVE / SHIELDING | PRODUCT OVERVIEW

	GROUNDING/SHIELDING FOAM	FABRIC WRAP SOLUTION	COPPER WRAP SOLUTION
Main application	electric grounding or shielding	electric grounding or shielding	electric grounding or shielding
Material	nickel-copper based electric conductive foam	nickel-copper based fabric + PU based foam	thin copper layer wrapped around PU based foam
Thickness range (mm)	0,5-8	1-12	1-12
Part size	tailored on customer request	tailored on customer request	tailored on customer request
Working range (compression %)	30-85	10-50	10-50
Temperature range starting from (°C)	-40 to +85	-40 to +110	-40 to +110
Resistance at a minimum compression of 35%	≤ 0,2Ω	-	-
Electric resistance	-	≤ 0,05Ω	≤ 0,05Ω

COMPRESSION FORCE vs RESISTANCE

Each DLZ-1xxx GY material compression needs to be tested separately for each application.

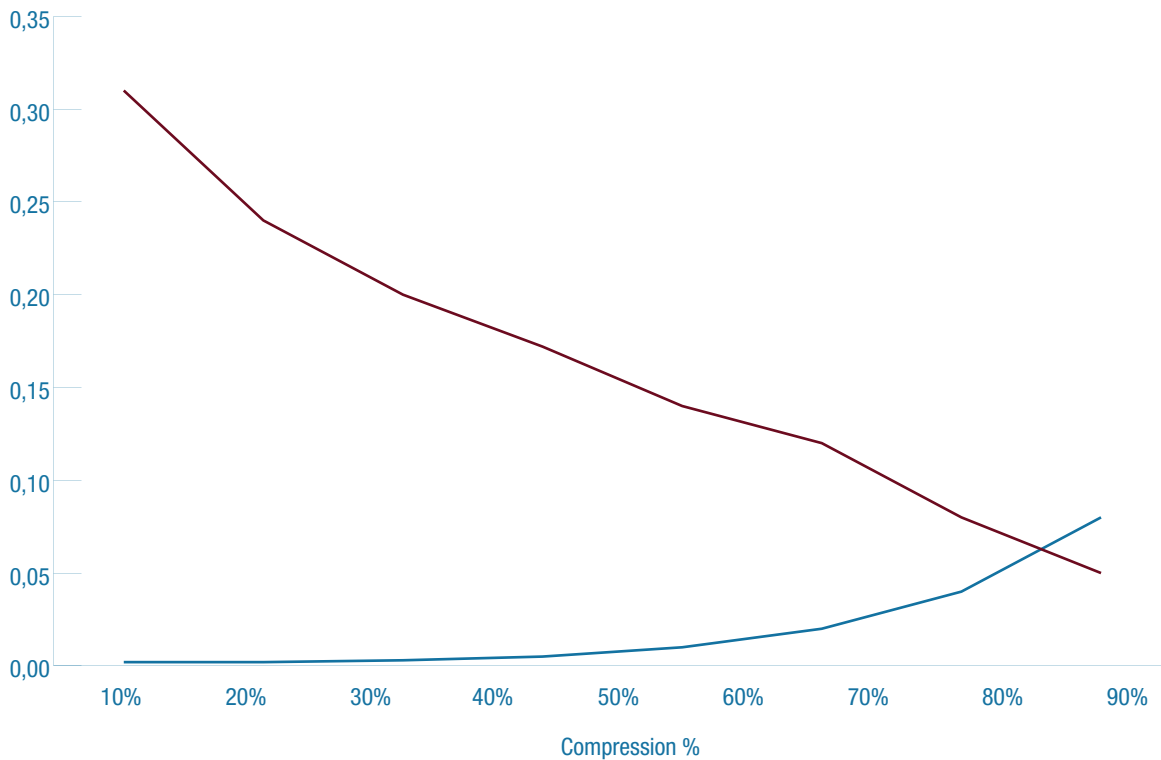

Our DLZ-range is available in several thicknesses,
from 0,5mm to 8mm in 0,5mm steps.

Resistance in Ohm ■
Compression force in N/mm² ■

GROUNDING MATERIALS | PRODUCT OVERVIEW

Customize your product.

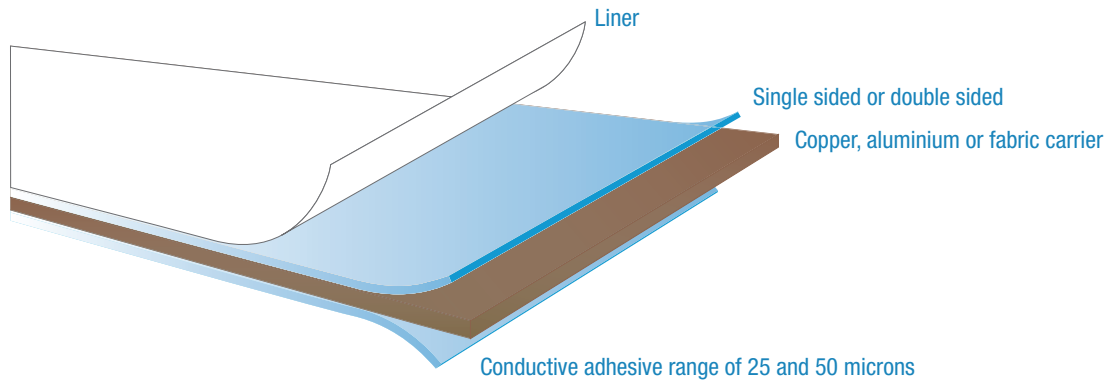

PRODUCT	CARRIER	NORMAL THICKNESS	ADHESIVE	FEATURES
EC-110xxx	copper	37-150 microns	single sided	conductive copper tape with low resistance
EC-210xxx	copper	62-200 microns	double sided	conductive copper tape with low resistance
EC-103xxx	aluminium	37-150 microns	single sided	conductive aluminium tape with low resistance
EC-203xxx	aluminium	62-200 microns	double sided	conductive aluminium tape with low resistance
EC-107xxx	fabric	50-100 microns	single sided	conductive fabric carrier tape with stable lifetime performance
EC-207xxx	fabric	50-150 microns	double sided	conductive fabric carrier tape with stable lifetime performance

In the close co-operation with customers, our Stokvis team can develop the best possible, tailor-made solution including the material and assembly solutions.

STOKVENT

Stokvent is a PET based ventilation solution developed by Stokvis. For electronic applications that must be sealed from liquid and particle ingress, but still be able to vent to avoid condensation, Stokvent is an excellent option.

Stokvent ensures high airflow under low pressure (2 mbar), protecting the application from water, oil and dust/metal particles.

Stokvents' shape and design, including adhesive layers can be tailored and supplied in sheet or roll format based on assembly requirements.

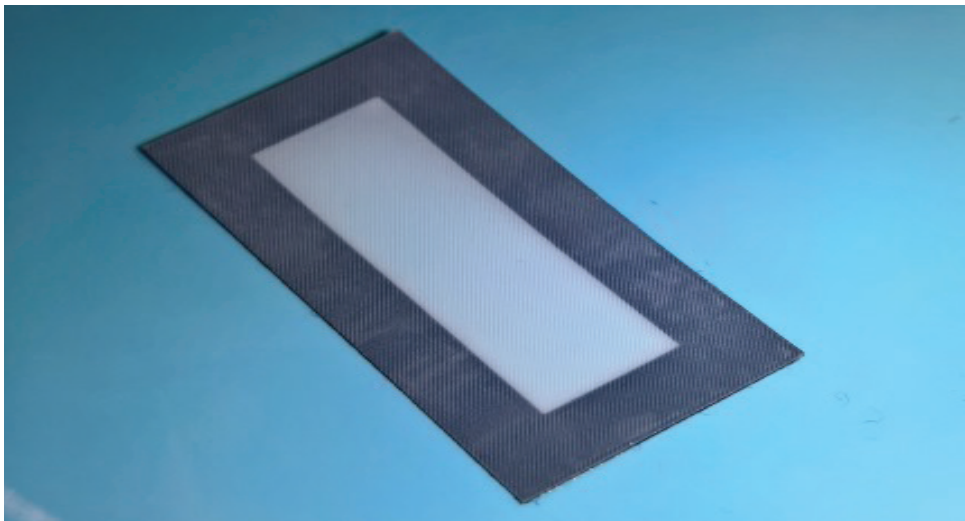

Temperature



UV Resistant



Moisture resistant



Sealing

STOKVENT | PRODUCT OVERVIEW

STOKVIS AIR-FLOW HOUSING VENTS SPECIFICATION

Target product type	Automotive lights (front/rear), 5G antenna boxes, LED streetlights, any sealed electronics boxes
Main vent application	Pressure equalization, dust/dirt/debris protection, water intrusion/protection, condensation reduction
Sizes	Any size based on customer specification
Filter type	Hydrophobic and oliophobic > 5 micron PET filter
Adhesive	PE foam or PET film with acrylic pressure sensitive adhesive
Operating temperature	-40 °C to 125 °C
Water vapour transmission rate	>700 mg/24hrs/cm ²
Water pressure protection	A protective cover can be required for high pressure water spray resistance
Housing material	Suitable for most typical plastics and metal materials for housing
Minimum airflow	21.6L/h @ 2 mbar/cm ²

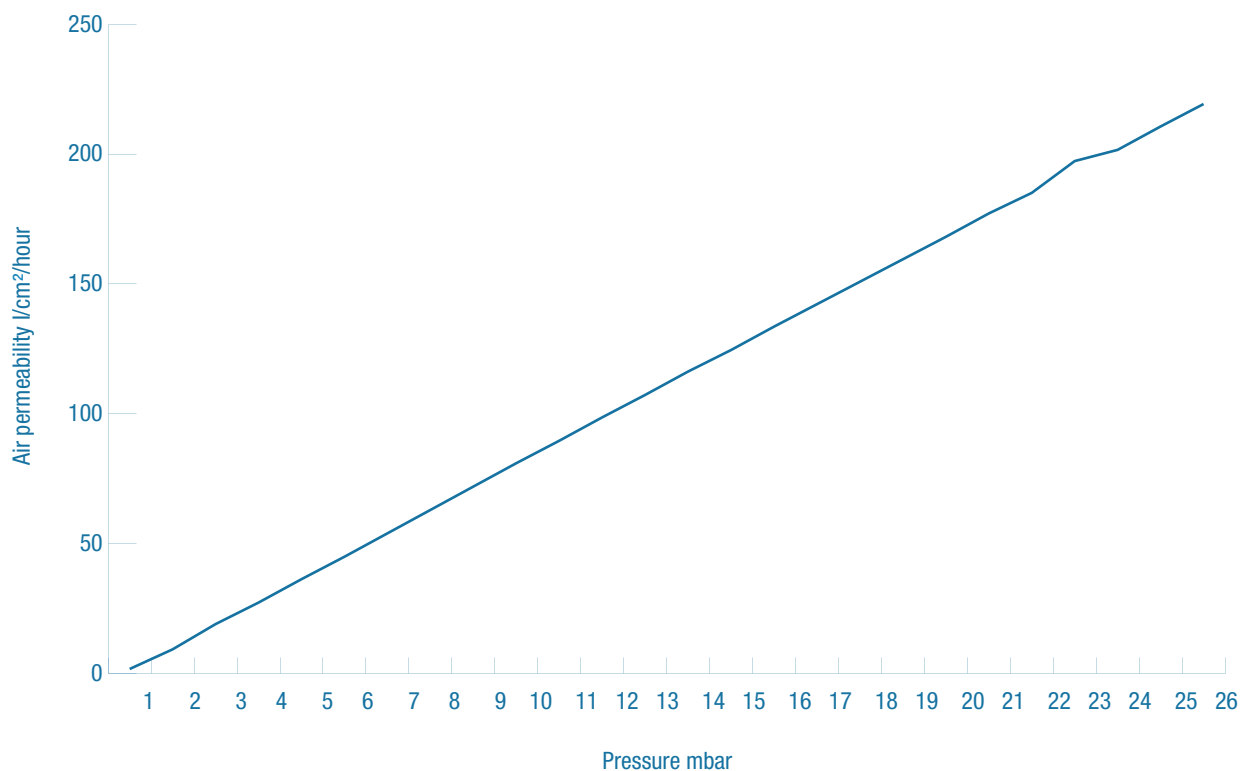

ITW FORMEX

ITW Formex flame retardant insulation films are seeing wide adoption in power system applications around the world. Formex understands power insulation safety needs and requirements as well as power engineering design considerations. Superior performance specifications make Formex the ideal insulation solution for power system components. It's score and foldable, flame retardant and has best in class electrical properties.

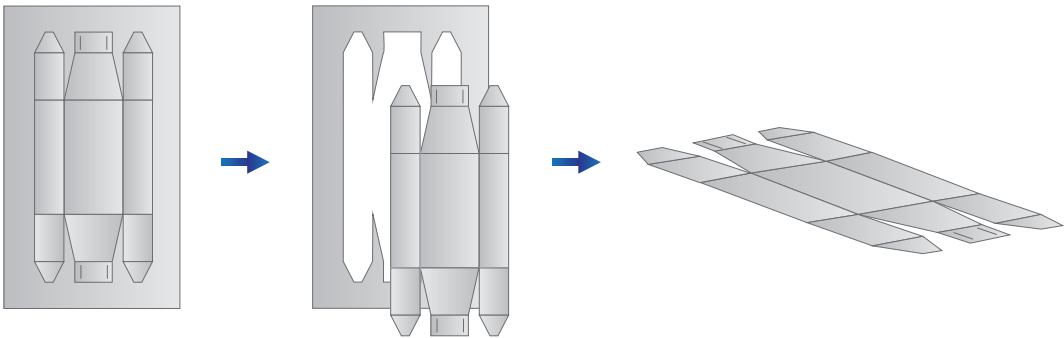

Parts are shipped as single flat pieces or on roll to minimize transport costs.

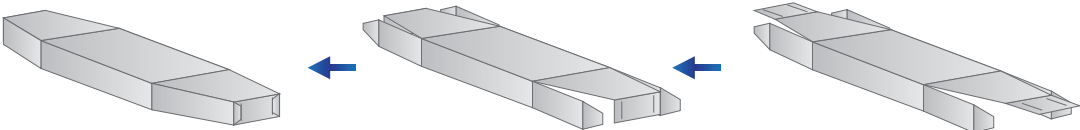

Score and fold from 2D to 3D design



Flame retardant



Best in class electrical properties

FORMEX I PRODUCT OVERVIEW

FORMEX SG & SE RANGE DATA

FORMEX SG 5	
Main application	electric insulation
Material	PP
Thickness (mm)	0,127
Dielectric breakdown (V)	13,125
Volume resistivity (Ohm-cm)	3,97x 10 ¹⁵
RTI - Relative Thermal Index (°C)	115
Heat deflection temp (°C)	121
Water absorbion (%)	0,06
Flammability UL-94	VTM-0

FORMEX SG 10	
Main application	electric insulation
Material	PP
Thickness (mm)	0,25
Dielectric breakdown (V)	22
Volume resistivity (Ohm-cm)	3,97x 10 ¹⁵
RTI - Relative Thermal Index (°C)	115
Heat deflection temp (°C)	121
Water absorbion (%)	0,06
Flammability UL-94	VTM-0

FORMEX SG 17	
Main application	electric insulation
Material	PP
Thickness (mm)	0,43
Dielectric breakdown (V)	24,82
Volume resistivity (Ohm-cm)	3,97x 10 ¹⁵
RTI - Relative Thermal Index (°C)	115
Heat deflection temp (°C)	121
Water absorbion (%)	0,06
Flammability UL-94	V-0

FORMEX SG 30	
Main application	electric insulation
Material	PP
Thickness (mm)	0,76
Dielectric breakdown (V)	32,4
Volume resistivity (Ohm-cm)	3,97x 10 ¹⁵
RTI - Relative Thermal Index (°C)	115
Heat deflection temp. (°C)	121
Water absorbion (%)	0,06
Flammability UL-94	V-0

FORMEX SG 40	
Main application	electric insulation
Material	PP
Thickness (mm)	1,02
Dielectric breakdown (V)	37,8
Volume resistivity (Ohm-cm)	3,97x 10 ¹⁵
RTI - Relative Thermal Index (°C)	115
Heat deflection temp. (°C)	121
Water absorbion (%)	0,06
Flammability UL-94	V-0

FORMEX SG 62	
Main application	electric insulation
Material	PP
Thickness (mm)	1,57
Dielectric breakdown (V)	45,26
Volume resistivity (Ohm-cm)	3,97x 10 ¹⁵
RTI - Relative Thermal Index (°C)	115
Heat deflection temp. (°C)	121
Water absorbion (%)	0,06
Flammability UL-94	V-0

FORMEX SE 10	
Main application	electric insulation
Material	PP
Thickness (mm)	0,25
Dielectric breakdown (V)	18,21
Volume resistivity (Ohm-cm)	3x 10 ¹⁵
RTI - Relative Thermal Index (°C)	90
Heat deflection temp. (°C)	106
Water absorbion (%)	0,06
Flammability UL-94	VTM-0

FORMEX SE 17	
Main application	electric insulation
Material	PP
Thickness (mm)	0,43
Dielectric breakdown (V)	20,57
Volume resistivity (Ohm-cm)	3x 10 ¹⁵
RTI - Relative Thermal Index (°C)	90
Heat deflection temp. (°C)	106
Water absorbion (%)	0,06
Flammability UL-94	V-0

FORMEX SE 20	
Main application	electric insulation
Material	PP
Thickness (mm)	0,5
Dielectric breakdown (V)	20,57
Volume resistivity (Ohm-cm)	3x 10 ¹⁵
RTI - Relative Thermal Index (°C)	90
Heat deflection temp. (°C)	106
Water absorbion (%)	0,06
Flammability UL-94	V-0

STOKSEAL

StokSeal is an elastomeric polyurethane or silicone foam which is highly compressible. It seals against water, moisture, dust and air. The material range includes a wide range of densities, thicknesses and softness levels. Due to its exceptional mechanical resistance, it is an ideal choice for high-end sealing, cushioning and shock absorption applications.

CRITICAL SELECTION CRITERIA

1. Function (type of sealing, primary & secondary function)
2. Area of application (external influences)
3. Force to compress (assembling material strength)
4. % of compression to achieve the sealing
5. Compression set (long term performance)
6. Design, gap and available space
7. Norms & specifications
 - Fogging
 - Outgassing
 - Flammability
 - Temperature

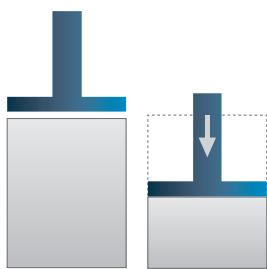

Good compression (flexible)

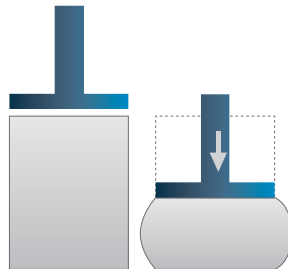

Bad compression (solid)



Moisture resistant



Temperature



Flamability



Sealing



For rough surfaces



Good compression



Tensile



UV resistant

STOKVIS GASKET COMPRESSION TOOL

With this unique Stokvis gasket compression tool, our Stokvis engineering team can calculate the Newton force effect generated by gasket compression. The calculation is based on nominal gasket compression, but the tool calculates the minimum and maximum compressions as well, which are generated by tolerance in customers' mechanical gap. With this compression tool, Stokvis can compare and report the effects the compression force has on different materials and calculate the Newtons per part, when the geometry of the part is known.

Compression Force Deflection (CFD) is a method that compresses the entirety of a material sample (generally about 10 cm) and records the amount of force (stress) that the sample exerts at different levels of compression strain. This allows a more exact determination of firmness at different compression levels.

EXAMPLE OF THE CALCULATED FORCE (N) EFFECT GENERATED BY GASKET COMPRESSION

	CFD	Minimum	Nominal	Maximum
Minimum compression	25,0%	0,0087	0,0119	0,0208
Nominal compression	40,5%	0	0	0
Maximum compression	56,0%	0,87	1,19	2,08
N.B. rounded up to nearest 0,5%		Nominal surface area mm ²		
				0,00

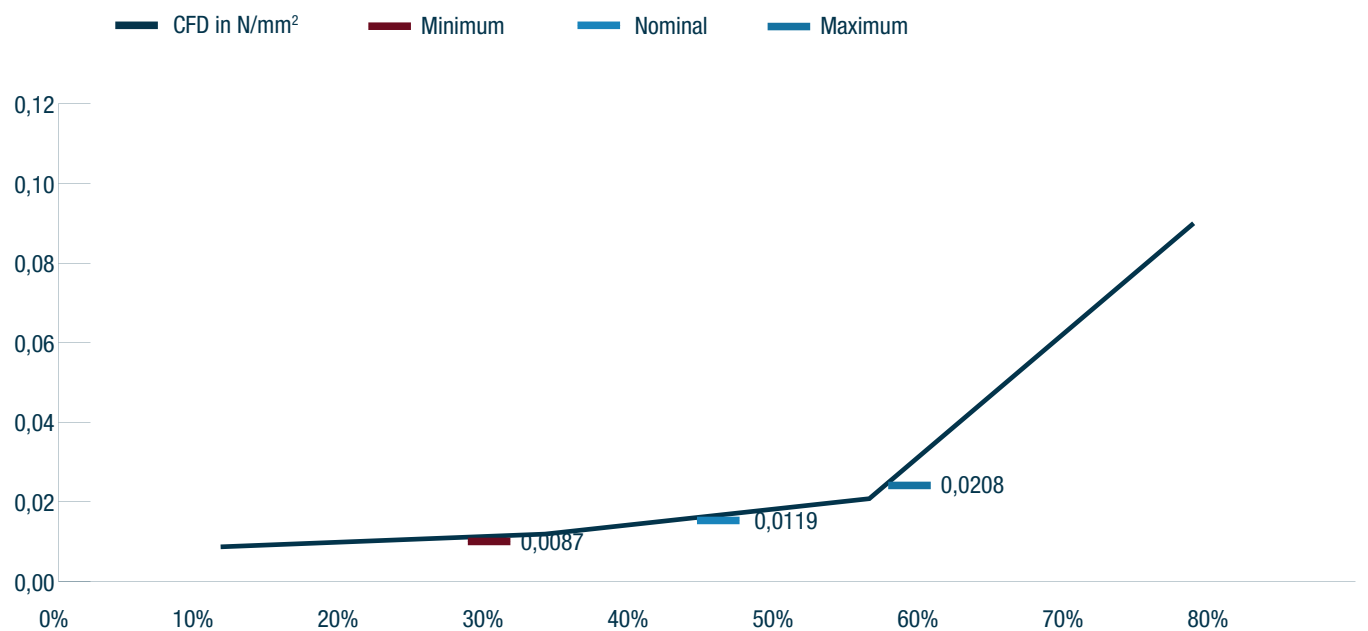

STOKSEAL | PRODUCT OVERVIEW

PU PRODUCTS

	PU Xsoft	PU Soft	PU Medium	PU Hard
Main application	sealing / cushion	sealing / cushion	sealing / cushion	sealing / cushion
Material	PU-foam semi closed cell	PU-foam semi closed cell	PU-foam semi closed cell	PU-foam semi closed cell
Thickness (mm)	0,3 - 12,7	0,79 - 12,7	0,79 - 12,7	0,3 - 12,7
Density (kg/m ³)	192 240 320 400	240 320 400	240 320 480	240 320 480
Compression set (% @ 23 °C)	2	2	5	5
Temperature range (°C)	-40 to +90	-40 to +90	-40 to +90	-40 to +90
CFD @ 30% (N/mm ²)	0,013 0,014 0,025 0,04	0,025 0,041 0,073	0,048 0,09 0,26	0,08 0,16 0,46
Flame rating UL	HBF	HBF	HBF	HBF

SILICONE PRODUCTS

	SIL Soft	SIL Medium	SIL Hard	SIL VHard
Main application	sealing / cushion	sealing / cushion	sealing / cushion	sealing / cushion
Material	silicone foam	silicone foam	silicone foam	silicone foam
Thickness (mm)	1,59 - 12,7	0,79 - 12,7	0,79 - 12,7	0,3 - 12,7
Density (kg/m ³)	240	350	370	430
Compression set (% @ 100 °C)	1,6	2,4	2,6	1,8
Temperature range (°C)	-55 to +200	-55 to +200	-55 to +200	-55 to +200
CFD @ 30% (N/mm ²)	0,038	0,082	0,126	0,185
Flame rating UL	V-0	V-0	V-0	V-0

CFD FORCE IN MPa @ 25% COMPRESSION

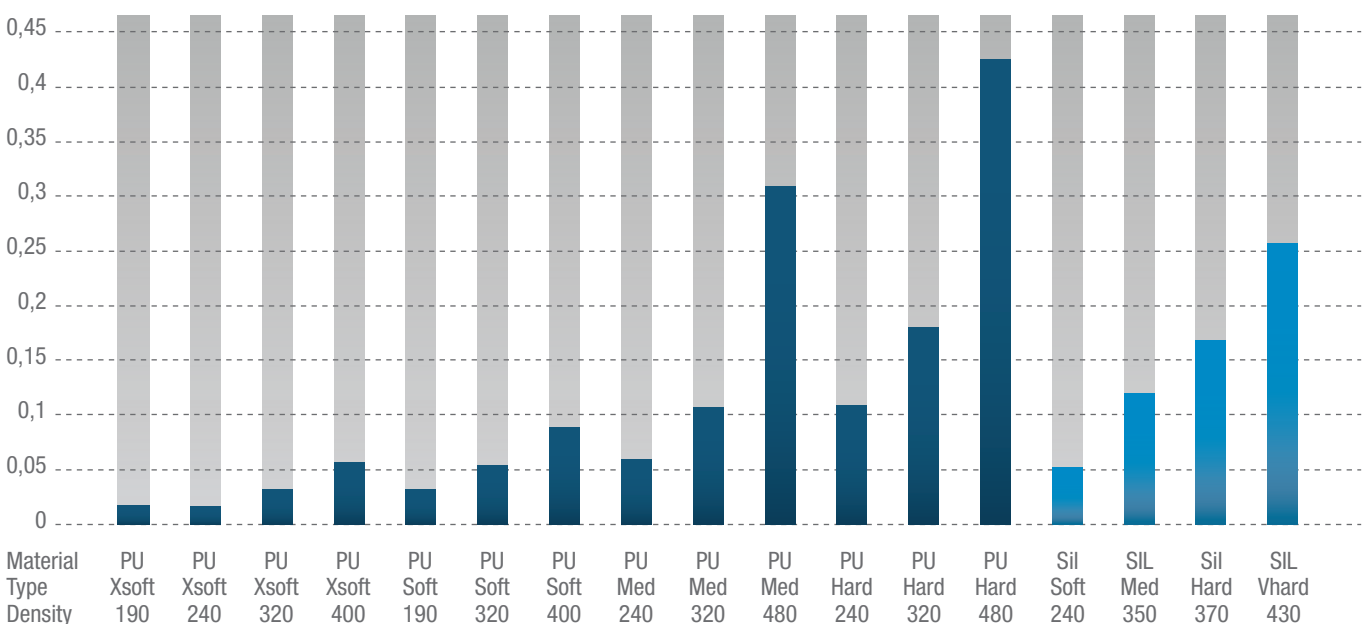

STOKBOND

The Stokvis Structural Bond Tapes are a unique range of Solid Core Acrylic Foam Tapes. These SB Tapes are made of several unique versions of Visco-Elastic acrylic adhesives that can be used for a wide range of applications in automotive to electronics and white goods. They can be used to bond plastics like PP, PVC, PMMA, PC, PET and aluminium, steel and glass.

All versions consist of a solid foam core that do not require an additional adhesive coating or a special thin coating of a "LSE" adhesive to improve adhesion on PP and specific plastics. With this technology we can maximize the benefits of the Visco-Elastic properties and reach new levels of secure bonding performances.

The "Visco" properties maximize the flow properties ensuring a complete wetting of the surface and improving final bond strength. The "Elastic" properties ensure a very high holding strength. This Visco-Elastic behavior ensures a long lasting high bond strength that is able to compensate for high stress, even under the most extreme environmental conditions.

In the close co-operation with customers, our Stokvis team can develop the best possible, tailor-made solution including the material and assembly solutions.

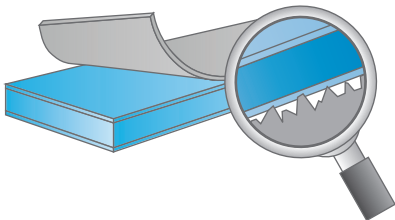

A soft conformable foam core coated with a thin adhesive layer. Limited contact area of the adhesive and no visco-elastic core.

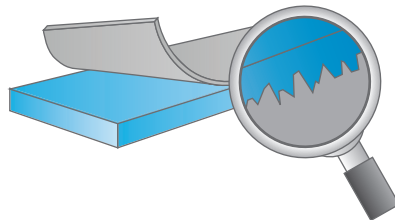

A conformable acyclic adhesive foam that is completely Visco-Elastic. Maximum contact area to increase bond strength.



Tensile



For rough surfaces



Distance



Perpendicular forces



Split



Pell

STOKBOND | PRODUCT OVERVIEW

SBT RANGE OF DIFFERENT ADHESIVE VERSIONS

HF Range			HS Soft Range			LF Range	PB Range
Gray up to 2.3 mm	White up to 2.3 mm	Transparent up to 1.5 mm	Black up to 1.2 mm	White up to 1.5 mm	Grey up to 1.5 mm	Gray up to 1.5 mm	Black from 0.15 to 0.3 mm

	HSxxxBA	HSxxxWH	HSxxxBA	HFxxxTR
Material (colour)	acrylic (black)	acrylic (white)	acrylic (black)	acrylic (transparent)
Thickness (mm)	0,3	0,5	1,6	0,5
Adhesion (stainless steel)	40 N/25mm	40 N/25mm	50 N/25mm	40 N/25mm
Static shear 23 °C	1,5 kg/625mm ²	1 kg/625mm ²	1 kg/625mm ²	1 kg/625mm ²
Static shear 70 °C	1 kg/625mm ²	0,5 kg/625mm ²	0,5 kg/625mm ²	0,5 kg/625mm ²
Temperature on short term (°C)	150	150	200	200
Temperature range starting from (°C)	-40 to +125	-40 to +125	-40 to +125	-40 to +125

	HFxxxGY	LFxxxGY	PBxxxBA
Material (colour)	acrylic (grey)	acrylic (grey)	copolymer foam (black)
Thickness (mm)	1,1	1,1	0,25
Adhesion (stainless steel)	80 N/25mm	75N/25mm	50 N/25mm
Static shear 23 °C	1,5 kg/625mm ²	1 kg/625mm ²	1,5 kg/625mm ²
Static shear 70 °C	1 kg/625mm ²	0,5 kg/625mm ²	0,5 kg/625mm ²
Temperature on short term (°C)	150	150	150
Temperature range starting from (°C)	-40 to +125	-40 to +125	-40 to +125



Belgium

China

Denmark

Germany

Finland

France

India

Italy

Mexico

Netherlands

Norway

Poland

Portugal

Russia

Spain

Czech Republic

United Kingdom

United States of America

Sweden

STOKVIS TAPES BENELUX BV

05/05/2022

Belgium

Mechelsesteenweg 586C/18/1/2

1800 Vilvoorde

Email: info@stokvistapes.be

Tel. +32 (0)22 55 06 11

Netherlands

Van Hennaertweg 10

2952CA Alblasterdam

Email: info@stokvistapes.nl

Tel. +31 (0)78 699 21 00

WWW.STOKVISTAPES.NL